



# 金桥铝材集团有限公司

( & , 3C , , , )

(KAE, KLT)

( , , , , , , , , )

(KAP)

KAP

KAP



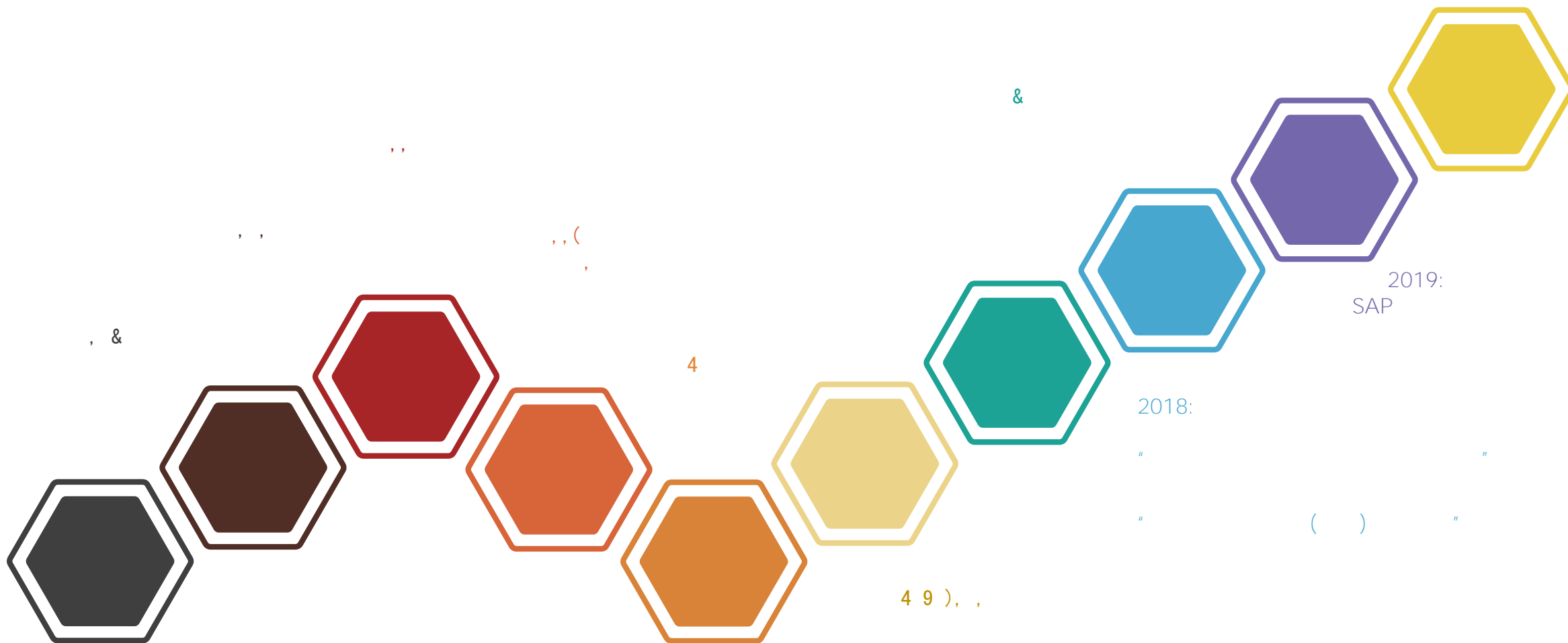



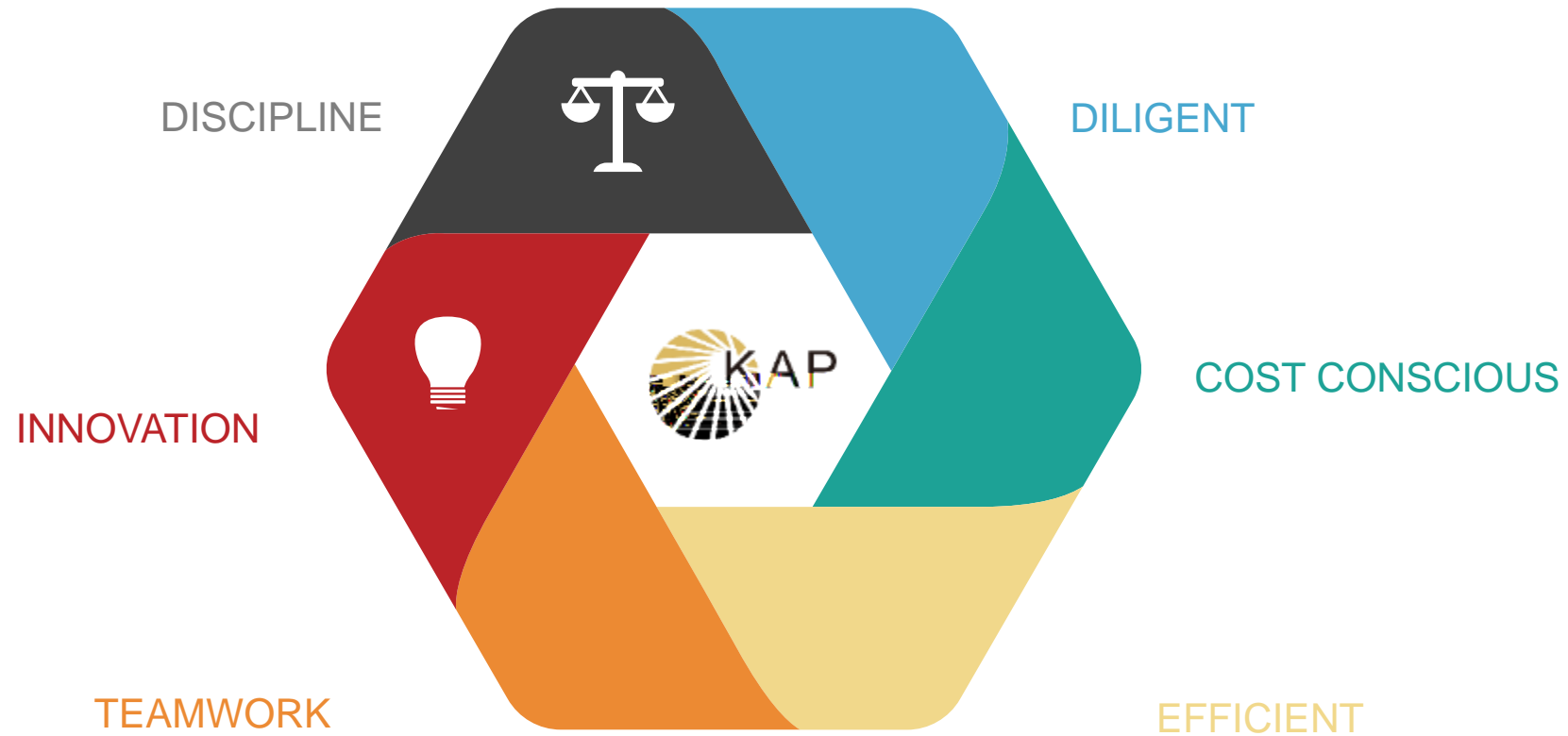

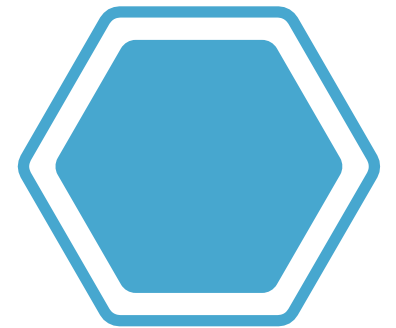
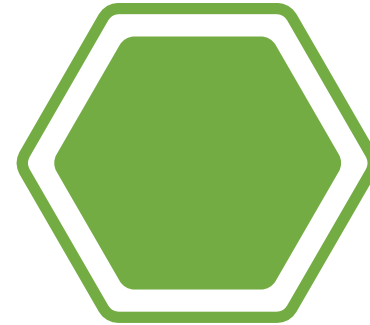
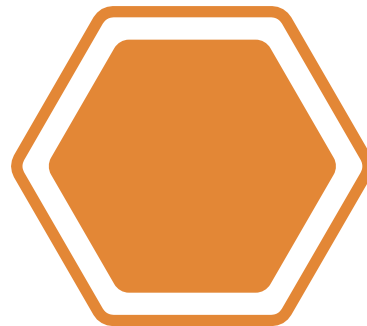
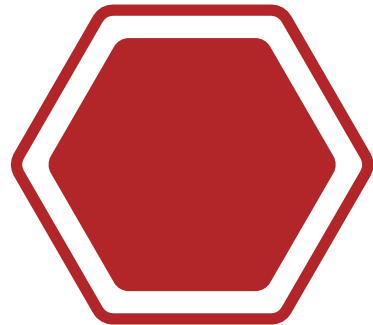
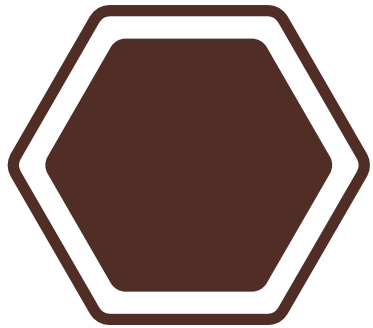

KAP

KAP



KAP





ISO 9001:2015

IATF 16949:2016

ISO 14001:2015  
GB/T 24001:2016

ISO 45001:2018

DNV ABS GL BV  
CCS



**SGS**

**CERTIFICATE**

awarded to  
**Taishan City Kam Kiu Aluminium Extrusion Co., Ltd.**  
 Shiqiao Industrial Zone, Dajiang County, Tai Shan, Guangdong Province  
 529202, Taishan City, Guangdong Province  
 China

SGS SA

IRIS Certification™ rules:2017  
 and based on  
 ISO/TS 22163:2017

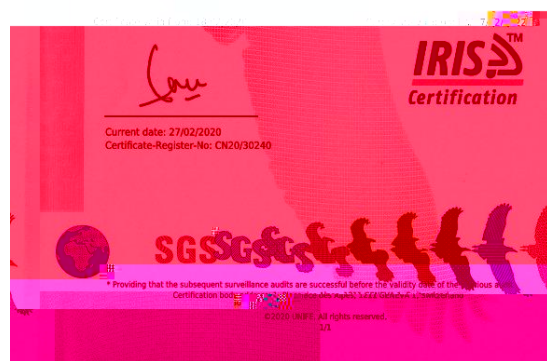

**SCS Global Services** does hereby certify that an independent assessment has been conducted on behalf of:

**Taishan City KAM KIU Aluminium Extrusion Co., Ltd.**  
 Shiqiao Industrial Zone, Dajiang County, Tai Shan, Guangdong, China

For the following product(s):  
**6063GR Aluminum Billet**

The product(s) meet(s) all of the necessary qualifications for:

**SCS RECYCLED CONTENT CERTIFIED**  
 Conforms to SCS Recycled Content Standard V7.0 for a 100% Pre-Consumer Recycled Aluminum\*.  
 content: 100% Recycled Aluminum (from unrecycled bottles, cans, and other consumer products).

Registration # SCS-RC-00125  
 Valid from: September 27, 2020 to September 20, 2021

**SCS global SERVICES**

Vice President  
 CA 94608 USA

Stanley Mathuram, PE  
 2000 Powell Street, Ste. 600, Emeryville

SCS

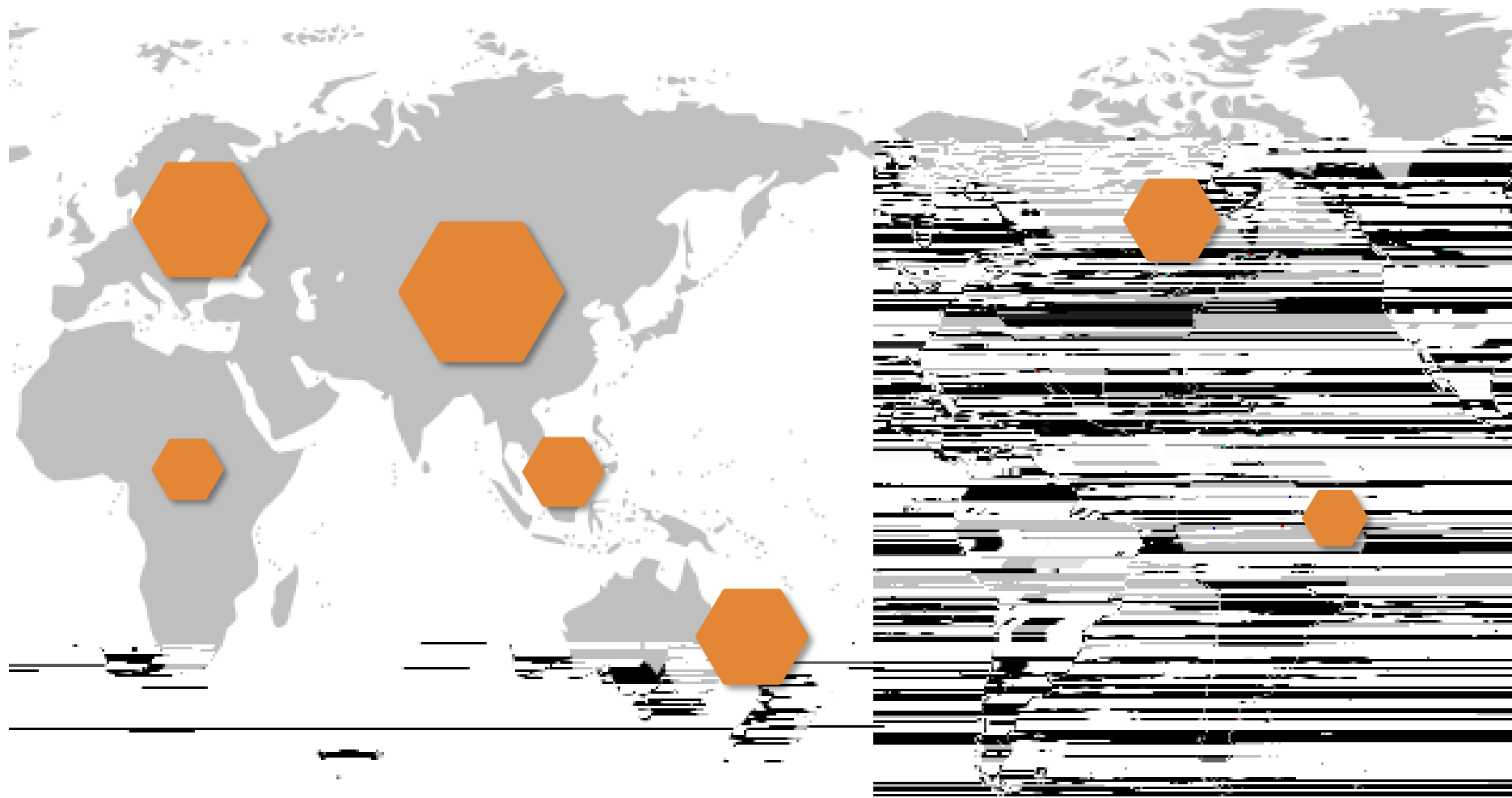

&

(85%)

(15%)

3C

3C



&

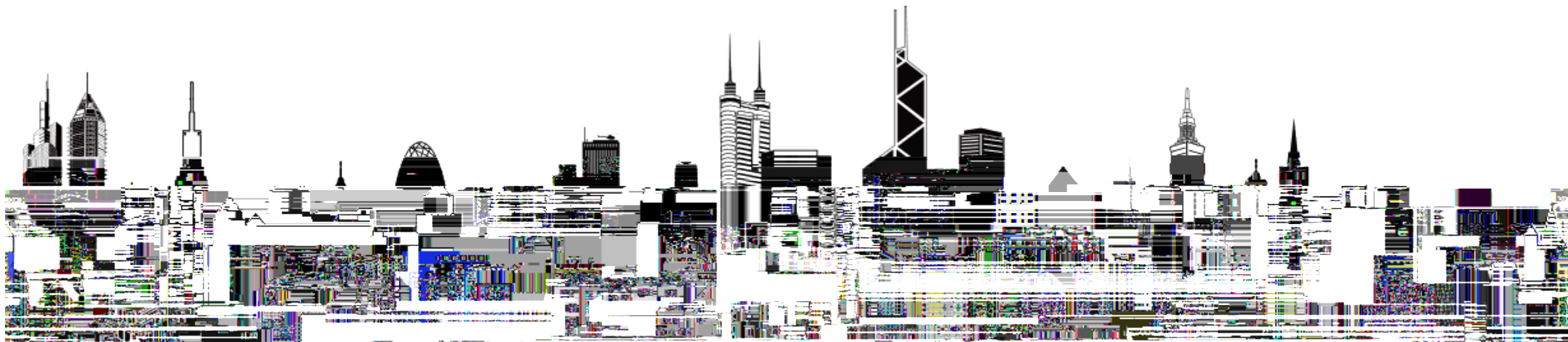

3C



7XXX

70%



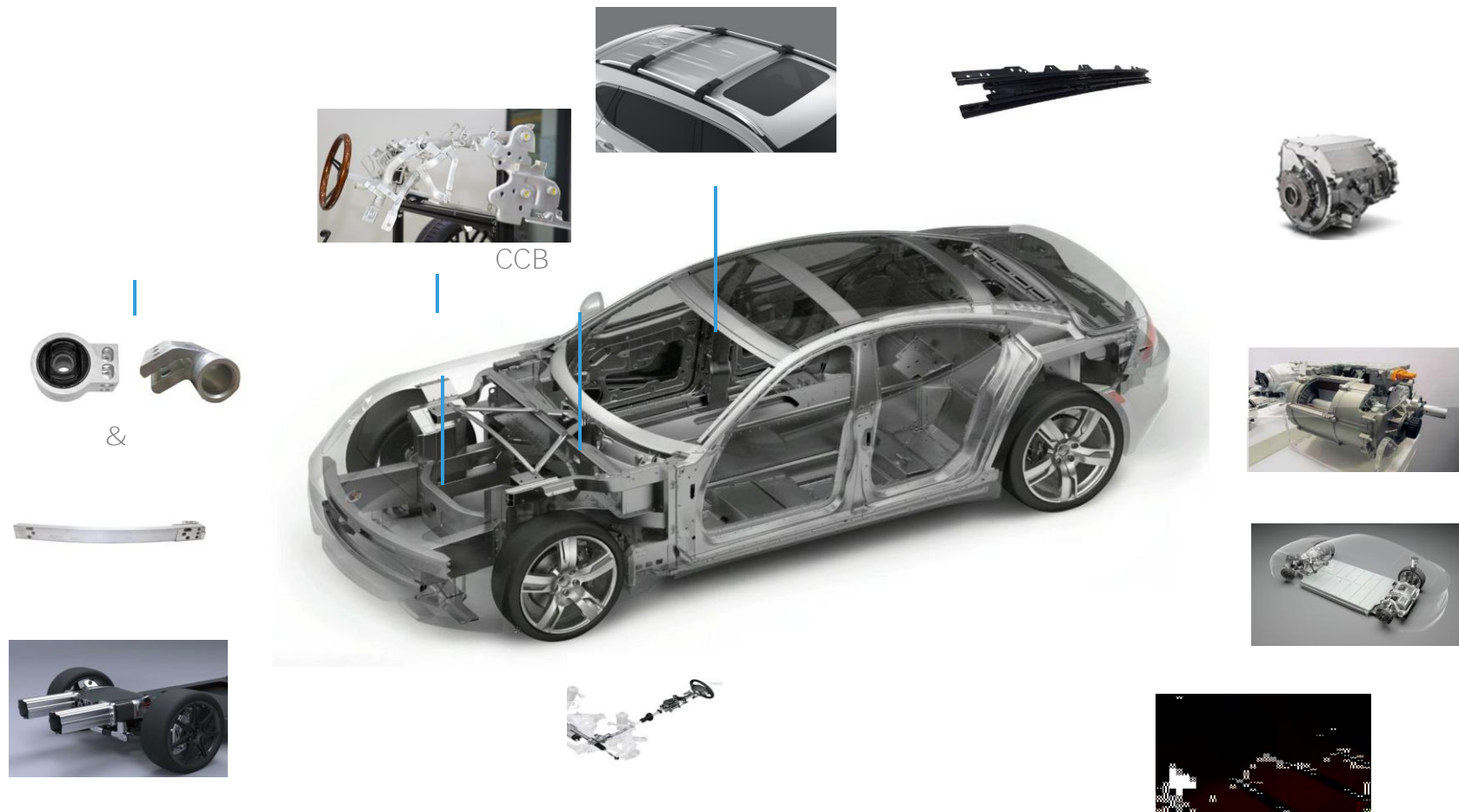



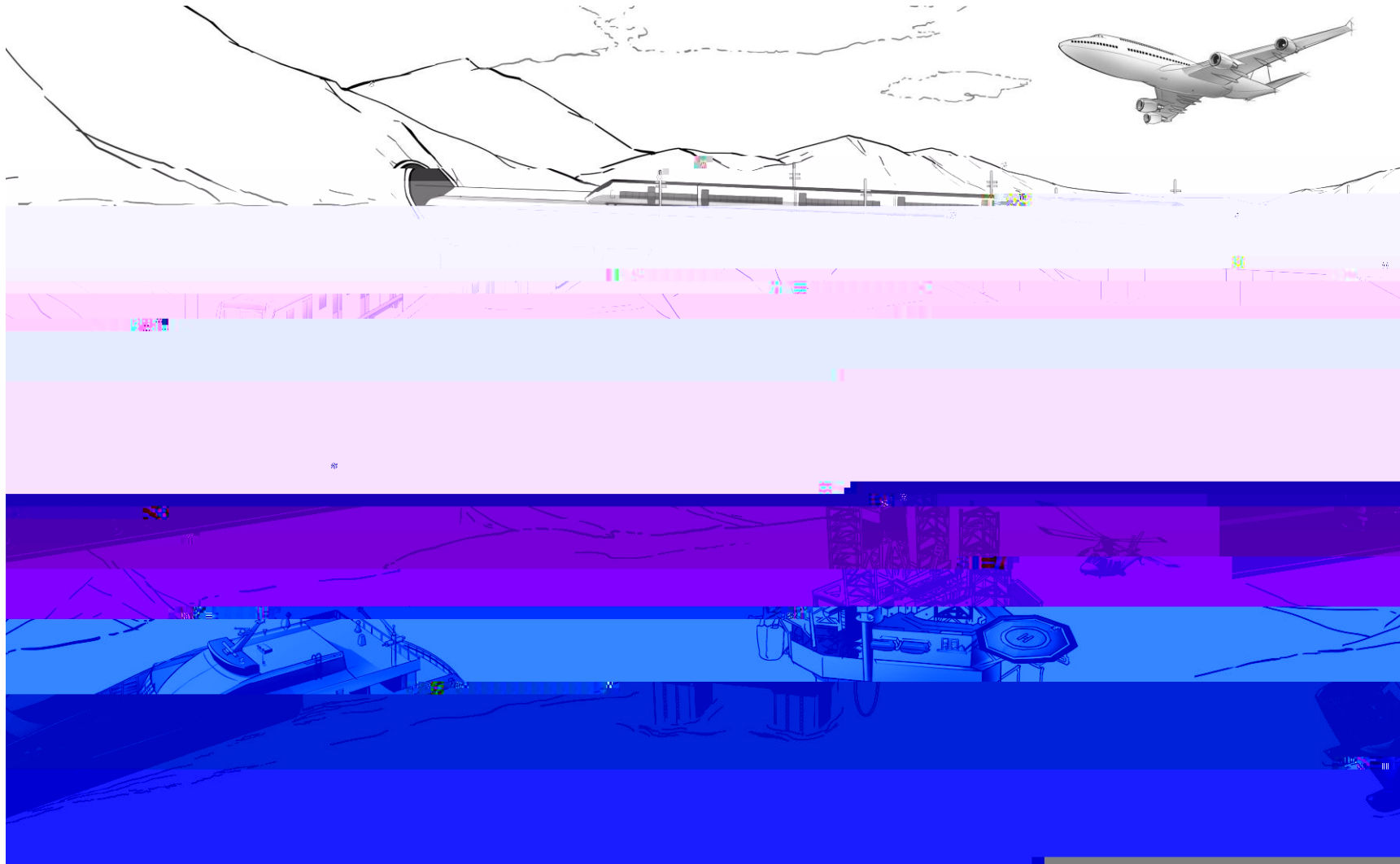



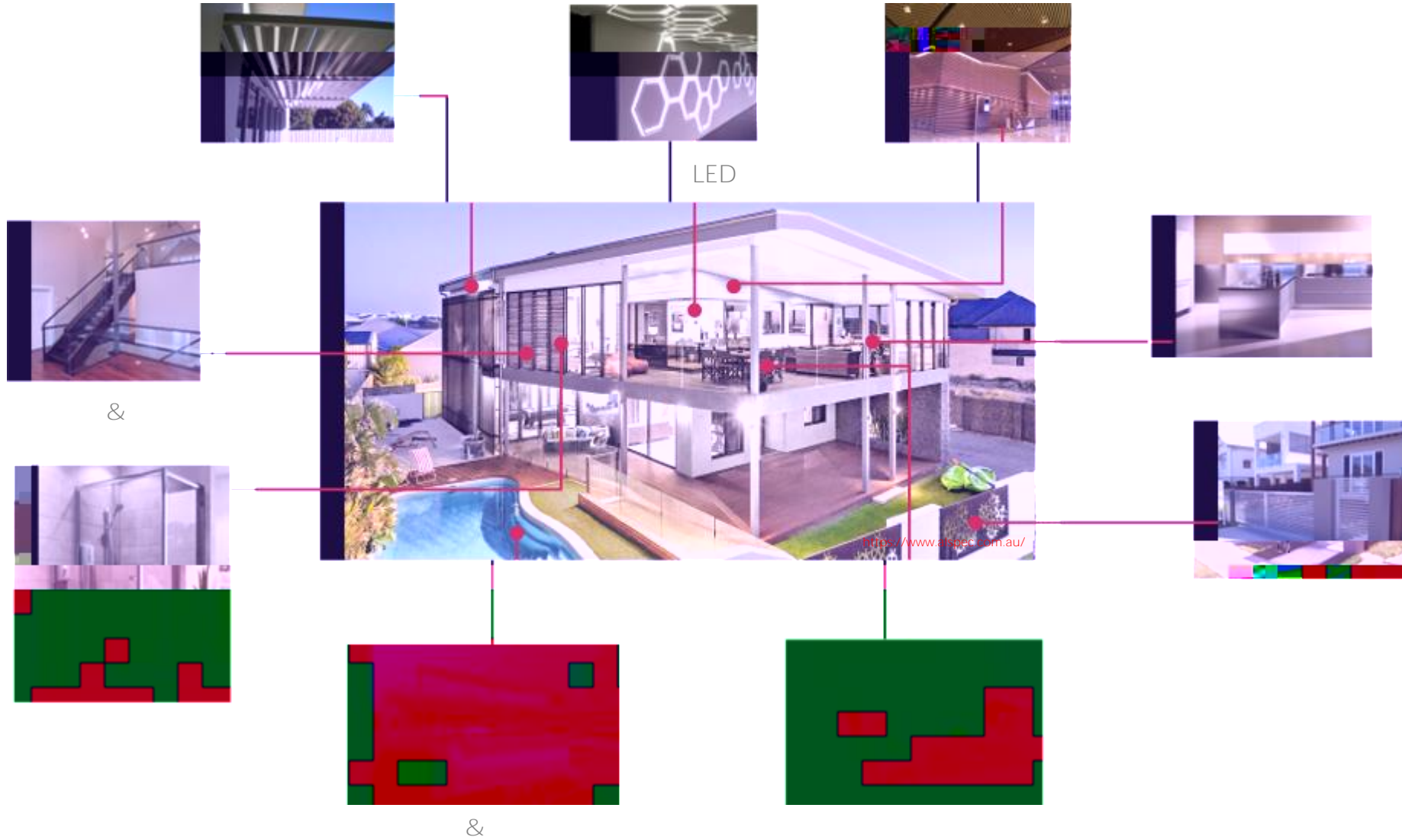



&

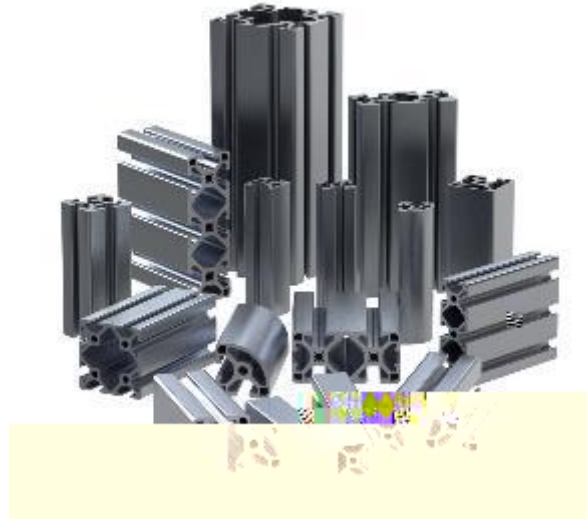
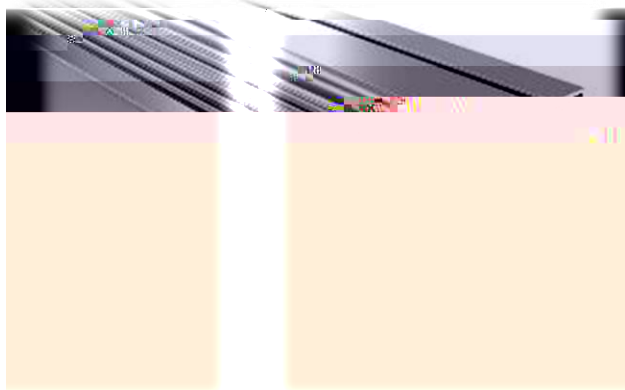

(KAE)

: 1983

: 389,000sqm.

: ~2500.



( ) (KLT)

: 2018  
: 166,500sqm.  
: 800 .

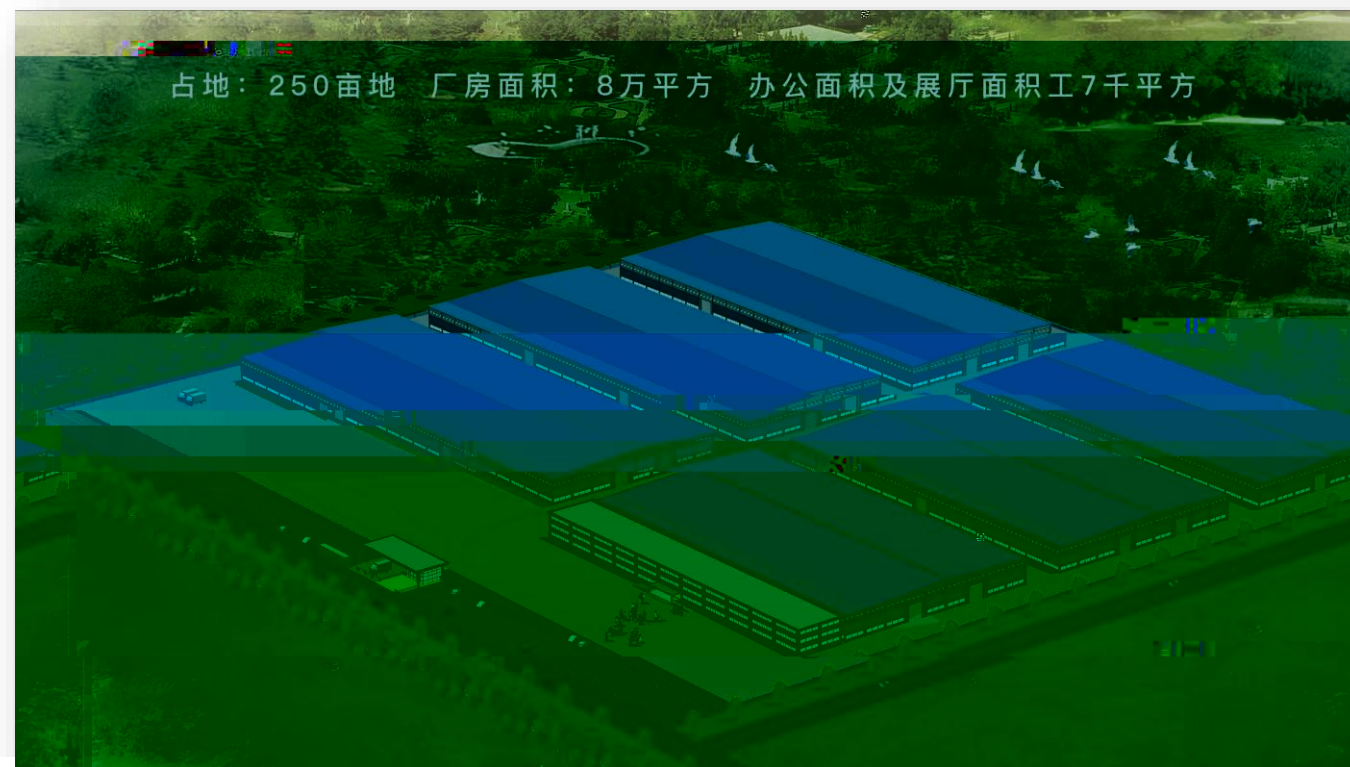

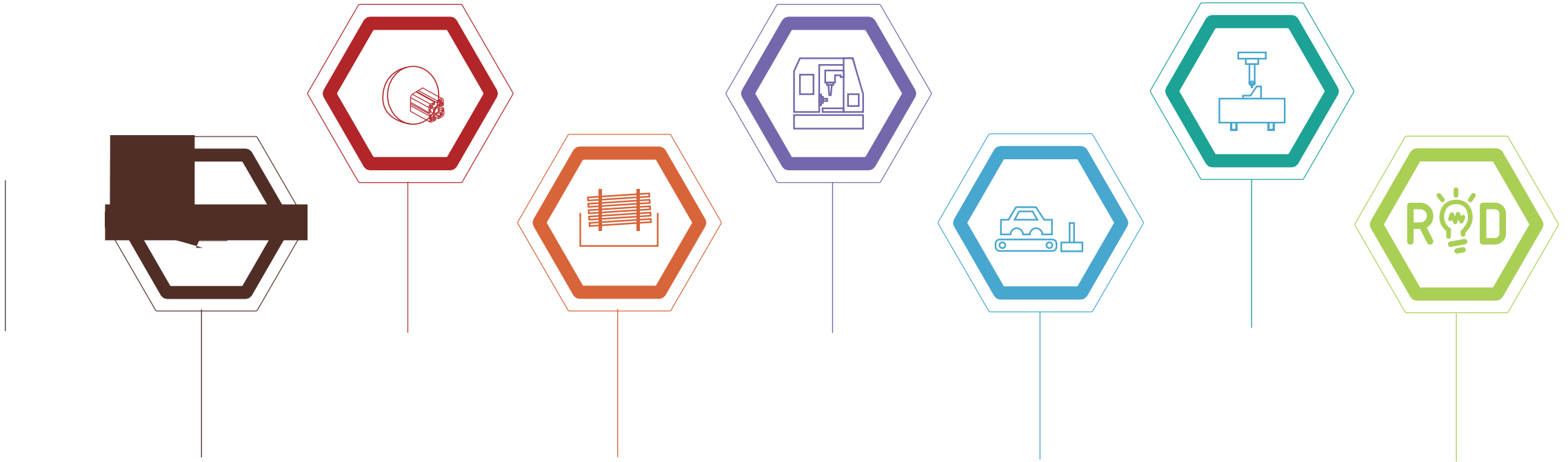



CNC



99.7%

1xxx, 2xxx, 3xxx, 5xxx, 6xxx, 7xxx

LNG,

16

	35	30	25	20
	1	4	9	2



35

:

( )	2800	1000
	2	2

:

( )	6180	3680	2800	2500	1800	1250	1100	880	550
	2	1	5	6	3	1	4	5	4

13





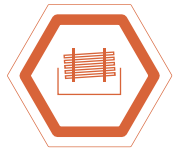
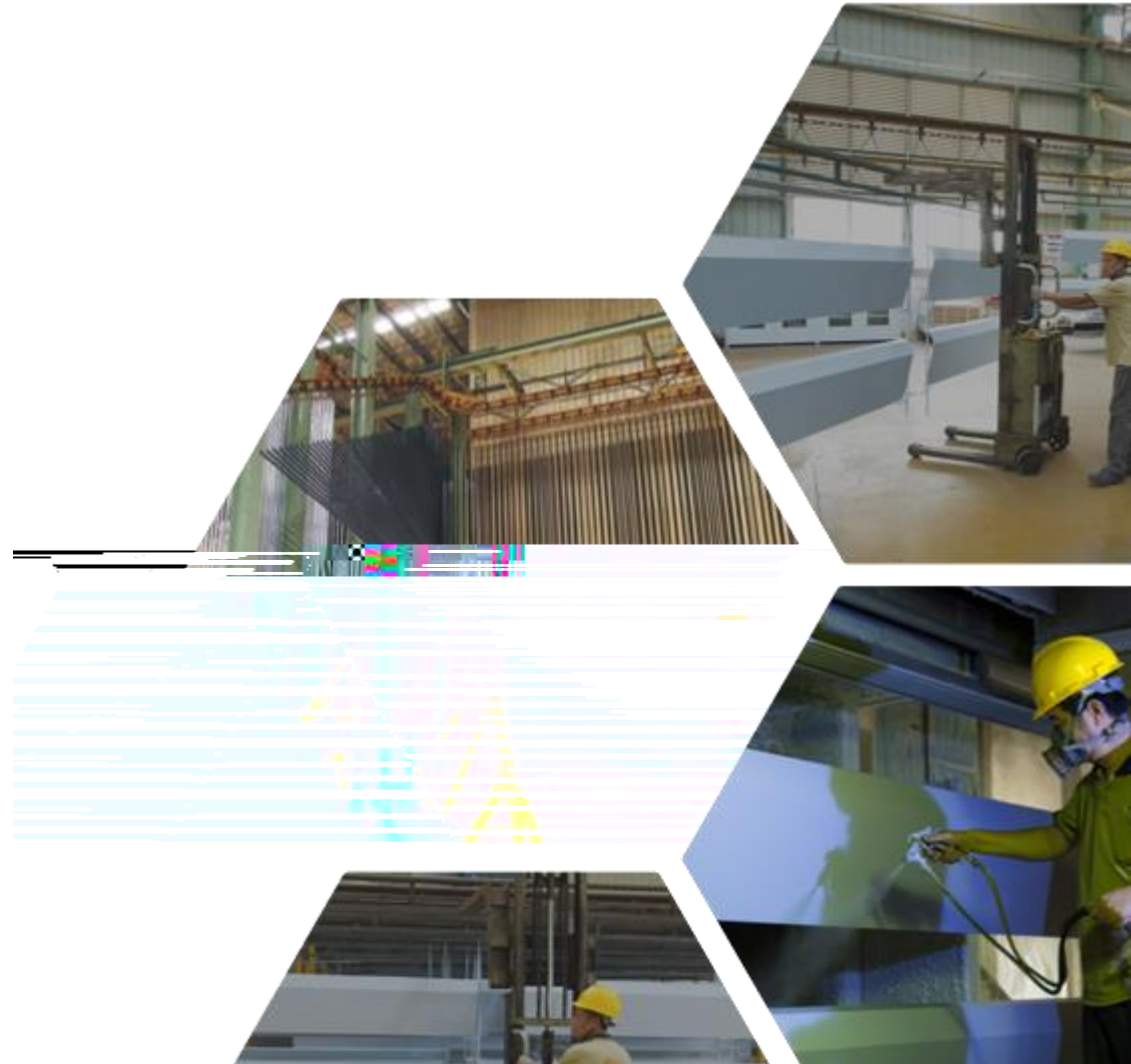

-  
-  
-  
-  
-

3 CNC

-  
-  
-  
-  
-

CNC



2017

<IATF16949

SAP



:

- CMM

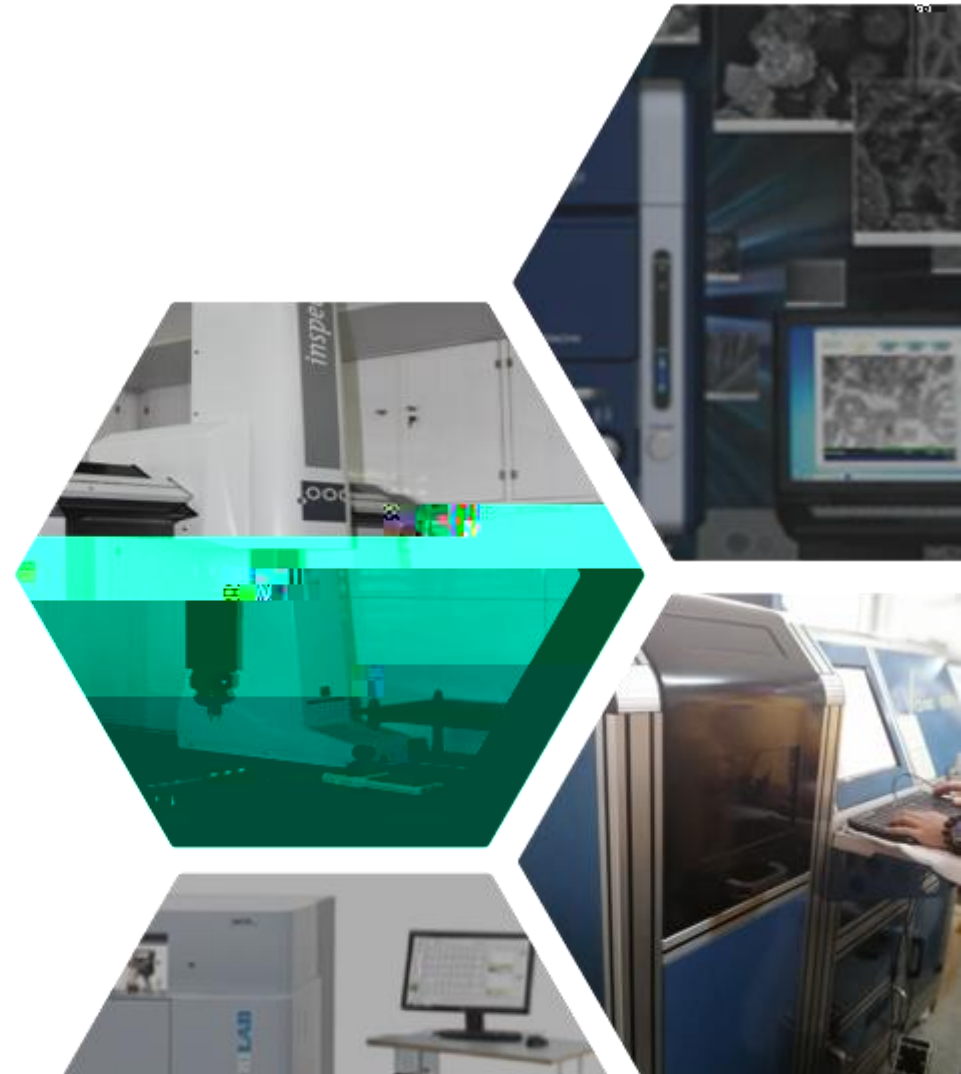

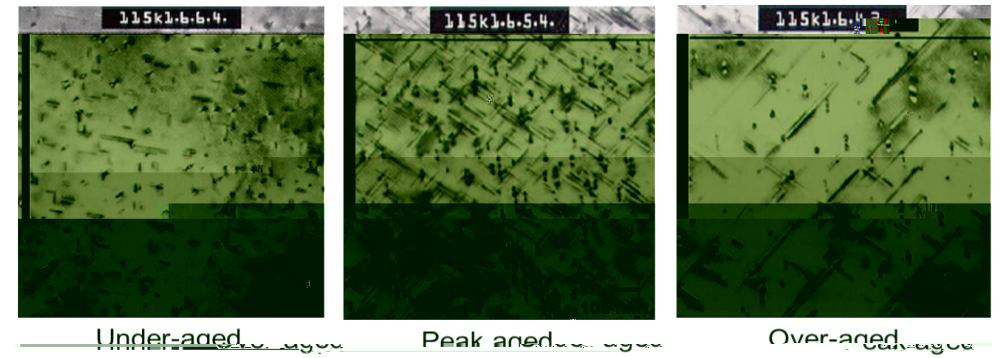

MIG/FSW

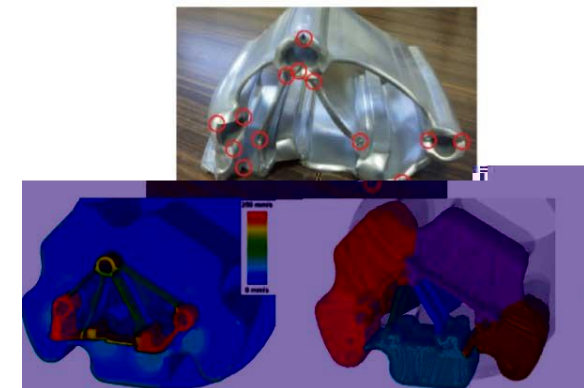
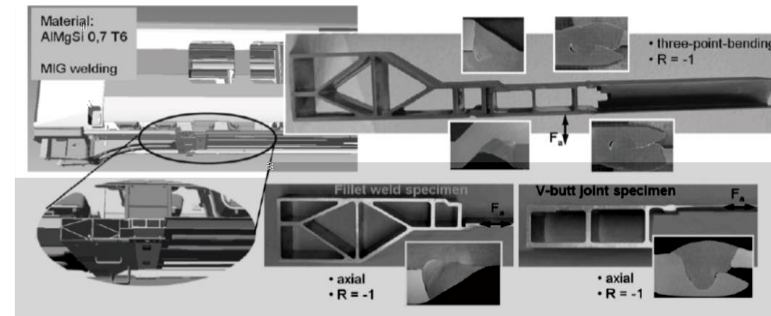





谢谢!